

#1 - Base

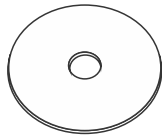

#2 - Base gasket

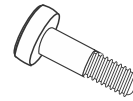

#3 - Base screw hinge pin

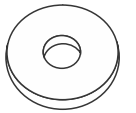

#4 - Synthetic spacing washer

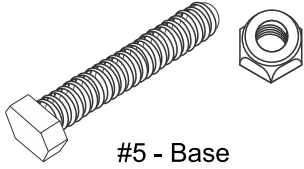

#5 - Base mounting bolt

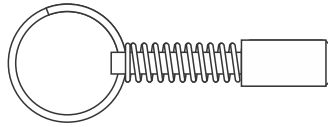

#6 - Locking pin assembly complete

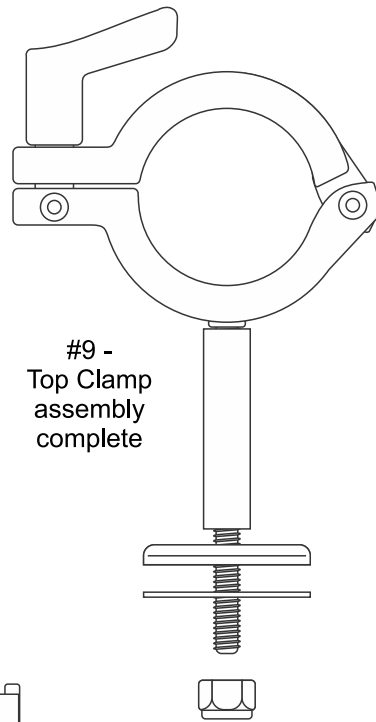

#9 - Top Clamp assembly complete



#13 - Locking pin Housing

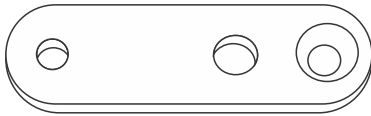

#7 - Pivot link arm

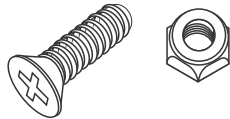

#8 - Pivot link bolt

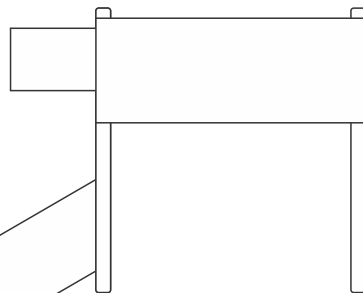

#11 - Yoke assembly

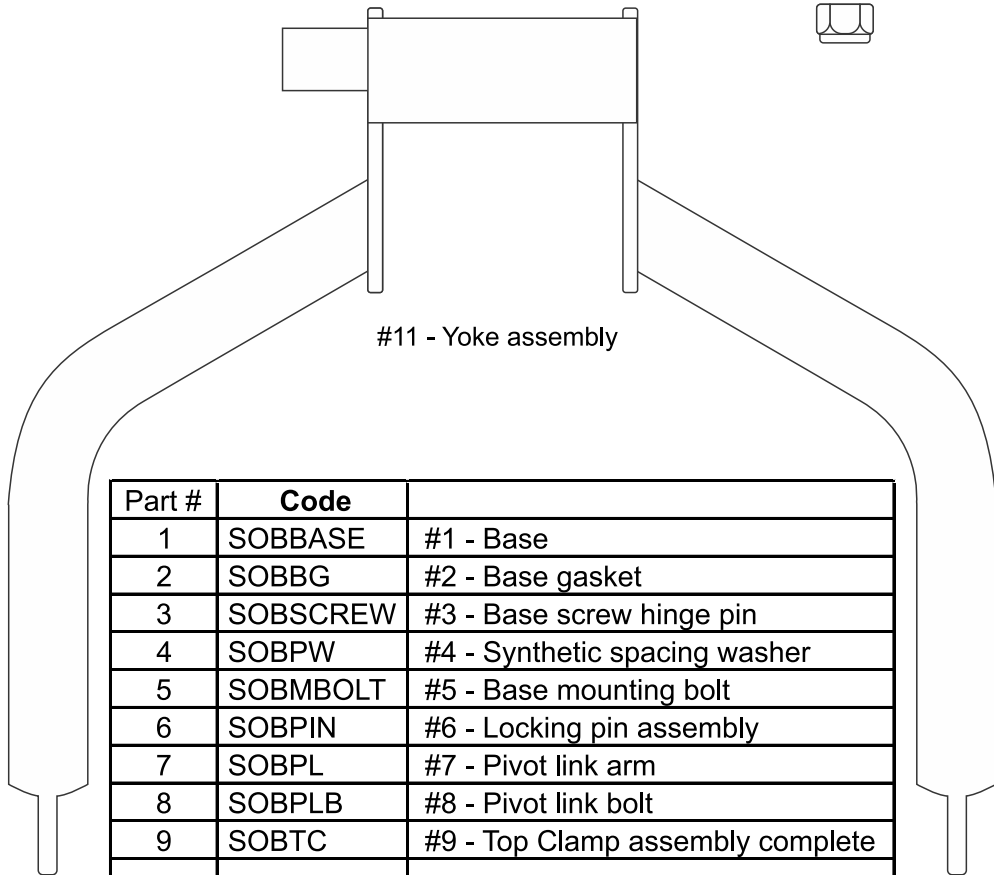

Part #	Code	Description
1	SOBBASE	#1 - Base
2	SOBBG	#2 - Base gasket
3	SOBSCREW	#3 - Base screw hinge pin
4	SOBPW	#4 - Synthetic spacing washer
5	SOBMBOLT	#5 - Base mounting bolt
6	SOBPIN	#6 - Locking pin assembly
7	SOBPL	#7 - Pivot link arm
8	SOBPLB	#8 - Pivot link bolt
9	SOBTC	#9 - Top Clamp assembly complete
11	SOBYA	#11 - Yoke assembly
12	SOBMT	#12 - Main tube
13	SOBLPH	#13 - Locking Pin Housing

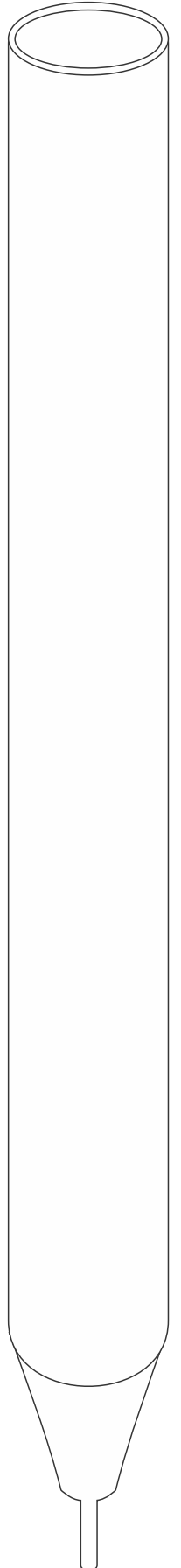

#12 - Main tube